

- Sandwich plates for vertical grouping
- Choice of channels interconnection
- Selection of 3/4-16UNF, 7/8-14UNF cavities
- Connection patterns of clear opening of size 04, 06 (D02, D03) in accordance with ISO standards

The sandwich plates are used for assembly of built-in two way and tree way valves in hydraulic circuits. The cast iron sandwich plate allows mounting of one or two valves with 3/4-16-UNF thread, or in case of nominal inside diameter size 06 also with the 7/8-14-UNF thread. Through-way channels P, T, A, B in the vertical direction allow so called vertical grouping. By assembling the

sandwich plates with the valves in the vertical direction more complex hydraulic control circuits are created. Top sandwich plate is closed by a cover plate or by a valve with a body, I.g. directional control valve.

In the basic finish the sandwich plates are zinc coated.

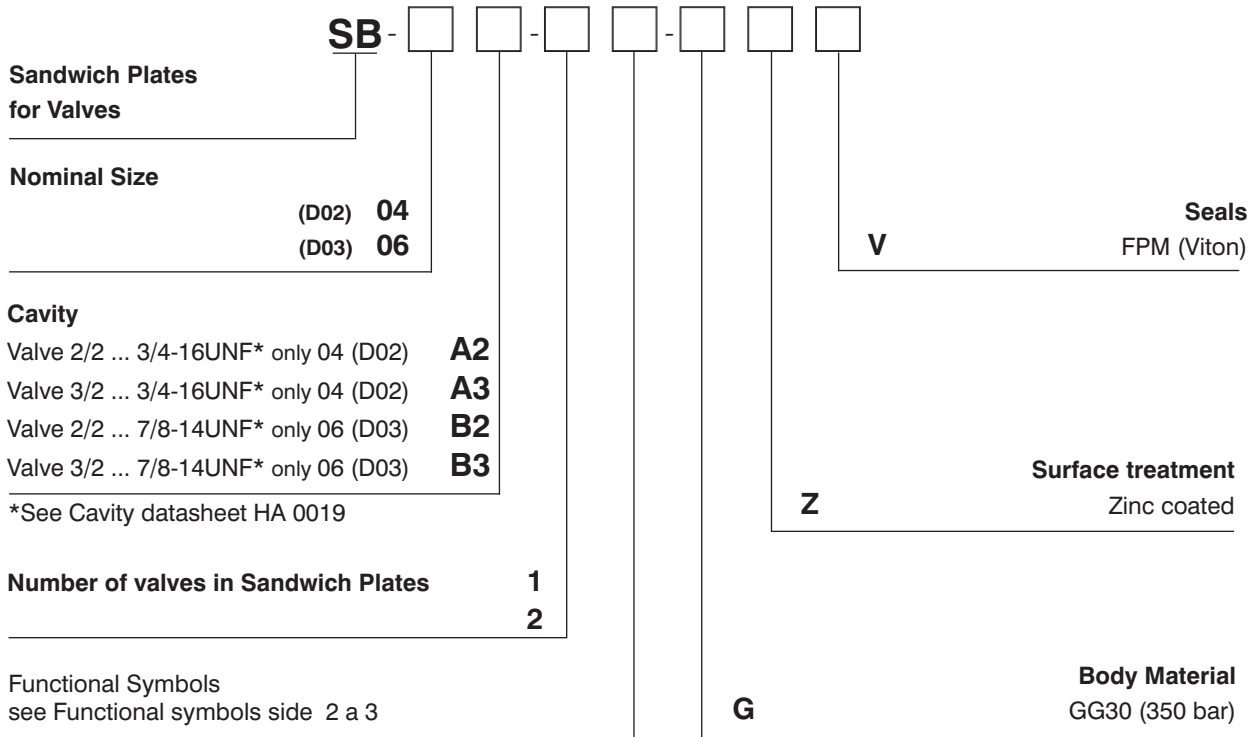

Functional Symbols

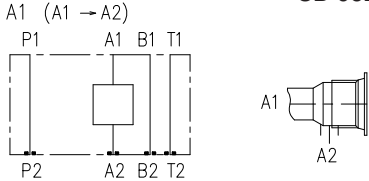
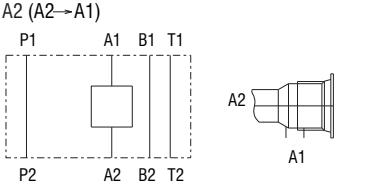
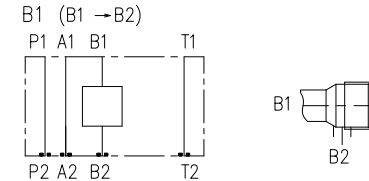
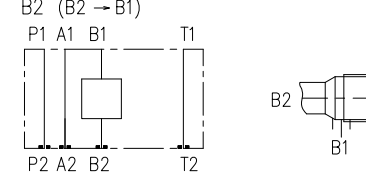
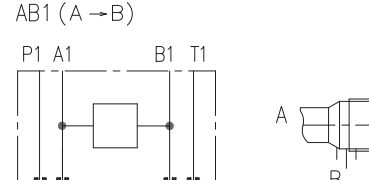
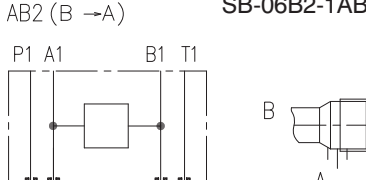
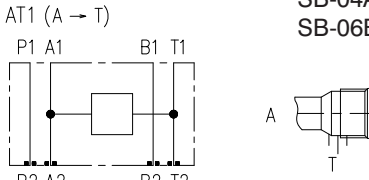
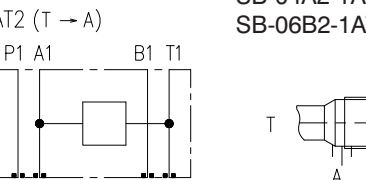
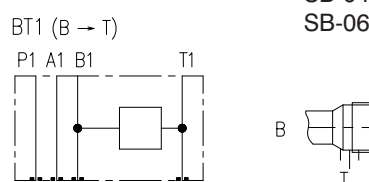
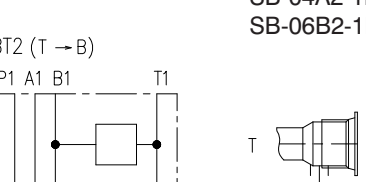
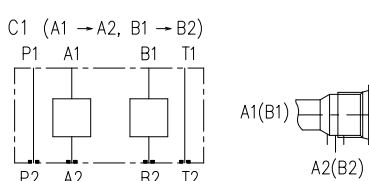
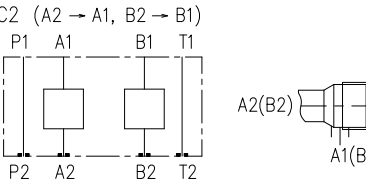
		Size	Cavity	Dimensions
		AxBxC/D[mm(in)]		
A1 (A1→A2) SB-04A2-1A1-*** SB-06B2-1A1-*** 	A2 (A2→A1) SB-04A2-1A2-*** SB-06B2-1A2-*** 	04	A2	36x40x74/37 (1.41x 1.57x2.91 /1.46)
		06	B2	45x50x86/30,5 (1.77x1.97x3.39 /1.2)
B1 (B1→B2) SB-04A2-1B1-*** SB-06B2-1B1-*** 	B2 (B2→B1) SB-04A2-1B2-*** SB-06B2-1B2-*** 	04	A2	36x40x74/18,5 (1.41x 1.57x2.91 /0.73)
		06	B2	45x50x86/12,5 (1.77x1.97x3.39 /0.49)
AB1 (A→B) SB-04A2-1AB1-*** SB-06B2-1AB1-*** 	AB2 (B→A) SB-04A2-1AB2-*** SB-06B2-1AB2-*** 	04	A2	36x40x74/31,5 (1.41x 1.57x2.91 /1.24)
		06	B2	45x50x86/30,5 (1.77x1.97x3.39 /1.2)
AT1 (A→T) SB-04A2-1AT1-*** SB-06B2-1AT1-*** 	AT2 (T→A) SB-04A2-1AT2-*** SB-06B2-1AT2-*** 	04	A2	36x40x74/31,5 (1.41x 1.57x2.91 /1.24)
		06	B2	45x50x86/30,5 (1.77x1.97x3.39 /1.2)
BT1 (B→T) SB-04A2-1BT1-*** SB-06B2-1BT1-*** 	BT2 (T→B) SB-04A2-1BT2-*** SB-06B2-1BT2-*** 	04	A2	36x40x74/18,5 (1.41x 1.57x2.91 /0.73)
		06	B2	45x50x86/12,5 (1.77x1.97x3.39 /0.49)
C1 (A1→A2, B1→B2) SB-04A2-2C1-*** SB-06B2-2C1-*** 	C2 (A2→A1, B2→B1) SB-04A2-2C2-*** SB-06B2-2C2-*** 	04	A2	36x40x98/37 (1.41x 1.57x 3.86 /1.45)
		06	B3	45x50x104/30,5 (1.77x1.97x 4.09 /1.2)

Functional Symbols

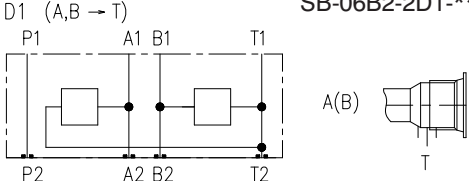
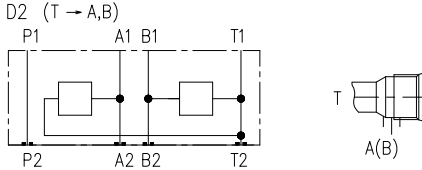
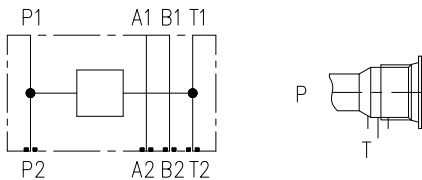
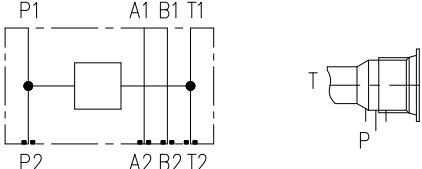
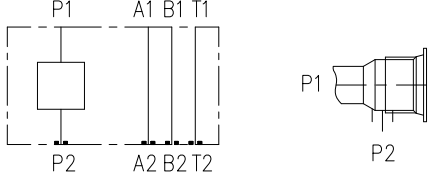
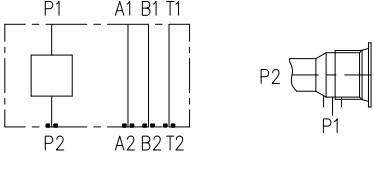
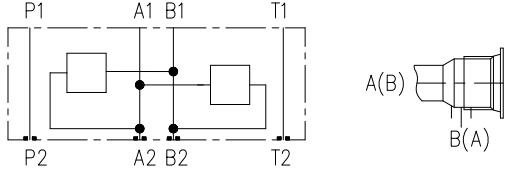
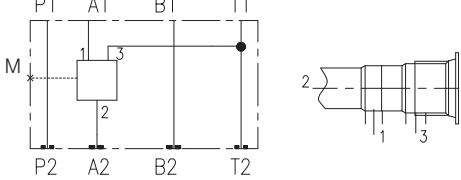
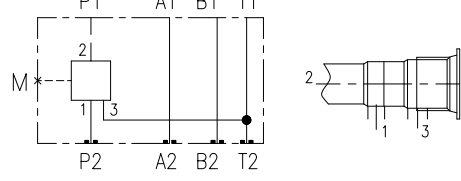
		Size	Cavity	Dimensions
		AxBxC/D[mm(in)]		
D1 (A,B → T) SB-04A2-2D1-*** SB-06B2-2D1-*** 	D2 (T → A,B) SB-04A2-2D2-*** SB-06B2-2D2-*** 	04	A2	36x40x98/37 (1.41x 1.57x 3.85 / 1.46)
		06	B2	45x50x86/30,5 (1.77x1.97x3.39 / 1.2)
PT1 (P → T) SB-04A2-1PT1-*** SB-06B2-1PT1-*** 	PT2 (T → P) SB-04A2-1PT2-*** SB-06B2-1PT2-*** 	04	A2	36x40x74/31,5 (1.41x 1.57x2.91 / 1.24)
		06	B2	45x50x86/30,5 (1.77x1.97x3.39 / 1.2)
P1 (P1 → P2) SB-04A2-1P1-*** SB-06B2-1P1-*** 	P2 (P2 → P1) SB-04A2-1P2-*** SB-06B2-1P2-*** 	04	A2	36x40x74/31,5 (1.41x 1.57x2.91 / 1.24)
		06	B2	45x50x86/30,5 (1.77x1.97x3.39 / 1.2)
C3 (B1 → A2, A1 → B2) SB-04A2-2C3-*** SB-06B2-2C3-*** 		04	A2	36x40x74/31,5 (1.41x 1.57x2.91 / 1.24)
		06	B2	45x50x104/30,5 (1.77x1.97x 4.09 / 1.2)
1A2 (A1 → A2, T) SB-06A3-1A2-*** SB-06B3-1A2-*** 		06	A3	45x50x73,5/42,5 (1.77x1.97x 2.89 / 1.67)
			B3	45x50x81/25,5 (1.77x1.97x 3.19 / 1.0)
1P2 (P2 → P1, T) SB-06A3-1P2-*** SB-06B3-1P2-*** 		06	A3	45x50x98/42,5 (1.77x1.97x 3.86 / 1.67)
			B3	45x50x98/42,5 (1.77x1.97x 3.86 / 1.67)

Sandwich Plates 04 and 06

Sandwich Plates 04 (D02) 3/4-16UNF

Sandwich Plates 06 (D03) 7/8-14UNF

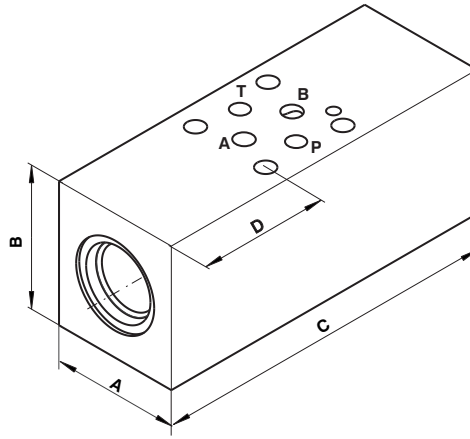

Installation Dimensions ISO 4401

Dimensions in millimeters and (inches)

ISO 4401-02-01-0-05

Size 04 (D02)

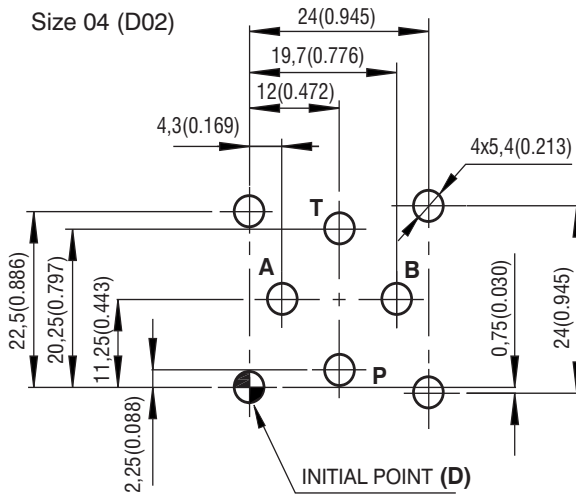

ISO 4401-03-03-0-05

Size 06 (D03)

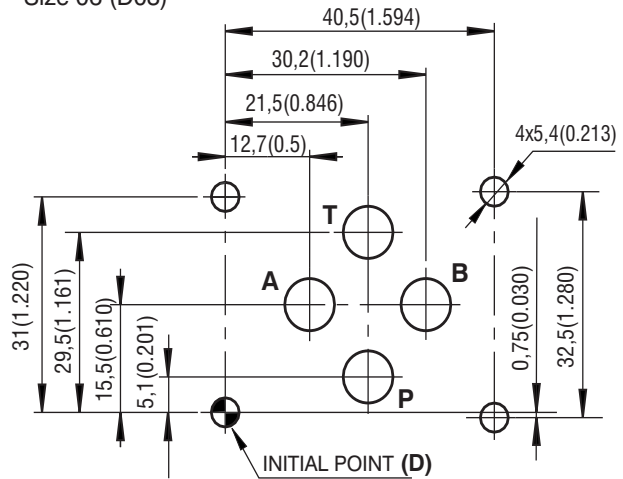

Spare Parts

Size	Seal kit	Dimensinos, number	Ordering number
04 (D02)	Viton - O-ring	7,5 x 1,8 (4 pcs.)	29267300
06 (D03)	Viton - O-ring	9,25 x 1,78 (4 pcs.)	20152400

Caution!

- The packing foil is recyclable.
- Mounting bolts for mounting the subplates are not included.
- The technical information regarding the product presented in this catalogue is for descriptive purposes only. It should not be construed in any case as a guaranteed representation of the product properties in the sense of the law.

ARGO-HYTOS s.r.o. CZ - 543 15 Vrchlábí
 tel.: +420-499-403 111
 e-mail: info.cz@argo-hytos.com
 www.argo-hytos.com