

GU 21		Innesto rapido DN5	Coupling DN5	Coupleur DN5	Kupplung DN5
1	2	3	4	5	
Corpo Body Corps Körper	Otturatore Valve Clapet Ventil	Molle Springs Ressorts Feder	Guarnizioni Seals Joint d'étanchéité Dichtung	Sfere Balls Billes Kugel	Innesti Plugs Embouts Stecker
Ottone UNI EN 12164 CW614N Nichelato Brass UNI EN 12164 CW614N Nickel plated Laiton UNI EN 12164 CW614N Nickelé Ms Vernickelt UNI EN 12164 CW614N	Ottone UNI EN 12164 CW614N Nichelato Brass UNI EN 12164 CW614N Nickel plated Laiton UNI EN 12164 CW614N Nickelé Ms Vernickelt UNI EN 12164 CW614N	Acciaio Inox AISI 302 Stainless Steel AISI 302 Acier Inox AISI 302 Edelstahl AISI 302	NBR NBR NBR	Acciaio Inox AISI 420 Stainless Steel AISI 420 Acier Inox AISI 420 Edelstahl AISI 420	Ottone UNI EN 12164 CW614N Nichelato Brass UNI EN 12164 CW614N Nickel plated Laiton UNI EN 12164 CW614N Nickelé Ms Vernickelt UNI EN 12164 CW614N

-20°C ÷ 80°C

0 ÷ 15 bar

5 mm

600 NI/min
(6 bar - Δp = 1bar)

SILICONE FREE

RoHS

REACH

Scala 1:1
Scale 1:1
Echelle 1:1
Maßstab 1:1

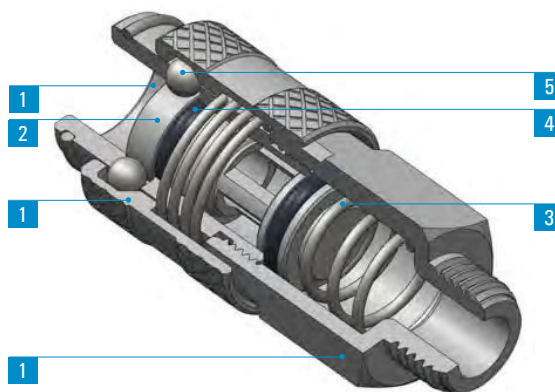

GU 21-11 Innesto rapido con filetto maschio Male coupling Coupleur mâle Einschraubkupplung

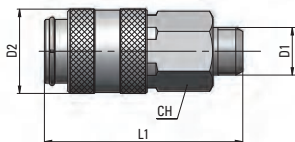

Type	D1	D2	L1	CH	g ΔΔ
11 00 18	G1/8	17	40	14	33,5
11 00 14	G1/4	17	42	17	43,6

GU 21-12 Innesto rapido con filetto femmina Female coupling Coupleur femelle Aufschraubkupplung

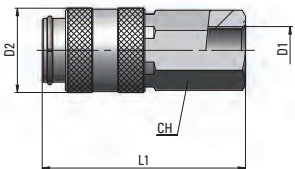

Type	D1	D2	L1	CH	g ΔΔ
12 00 18	G1/8	17	41	14	37
12 00 14	G1/4	17	46	17	53

GU 21-13 Innesto rapido con portagomma Coupling with hose connection Coupleur avec douille cannelée Kupplung mit Schlauchtülle

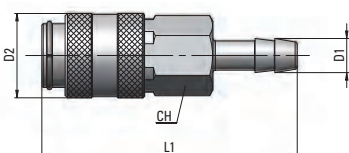

Type	Ø Tubo	D1	D2	L1	CH	g ΔΔ
13 04 00	4	4.9	17	51,5	14	34
13 06 00	6	6.9	17	51,5	14	35,1

GU 21-15

Innesto rapido con calzamento

Coupling with nut fitting

Coupleur avec raccord à écrou

Kupplung mit Überwurfverschraubung

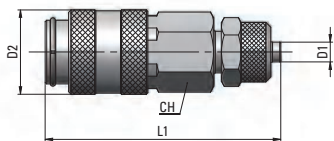

Type	D1	D2	L1	CH	g Δ
15 06 00	6x4	17	47,5	14	38
15 08 00	8x6	17	48,5	14	39,7

GU 21-20

Innesto con filetto maschio

Male plug

Embout mâle

Einschraubverschlußnippel

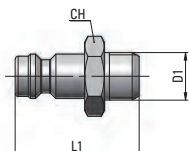

Type	D1	L1	CH	g Δ
20 00 18	G1/8	25	14	11,4
20 00 14	G1/4	27	17	19

GU 21-21

Innesto con filetto femmina

Female plug

Embout femelle

Aufschraubverschlußnippel

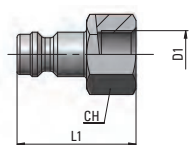

Type	D1	L1	CH	g Δ
21 00 18	G1/8	24	14	13,3
21 00 14	G1/4	27	17	19,7

GU 21-22

Innesto con portagomma

Plug with hose connection

Embout avec douille cannelée

Schlauchtülle

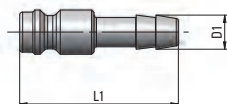

Type	\emptyset Tubo	D1	L1	g Δ
22 04 00	4	4,9	32	5,8
22 06 00	6	6,9	32	7,2

GU 21-23

Innesto con raccordo a calzamento

Plug with nut fitting

Embout avec raccord à écrou

Verschlußstübe mit Überwurfmutter

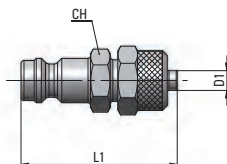

Type	D1	L1	CH	g Δ
23 06 00	6x4	31,5	11	15,1
23 08 00	8x6	32,5	13	20,2

GU 21-24

Innesto con molla di protezione

Plug with hose protection spring

Embout avec ressort protection tube

Verschlußstübe mit Knickschutzfeder

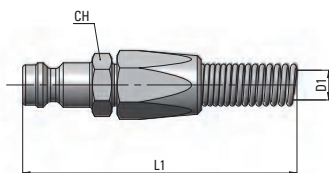

Type	D1	L1	CH	g Δ
24 06 00	6x4	110	11	23,9
24 08 00	8x6	120	13	30,5