

Pressure Relief Valve, Poppet Type, Direct Acting

SR1A-A2

3/4-16 UNF • Q_{max} 30 l/min (8 GPM) • p_{max} 350 bar (5100 PSI)

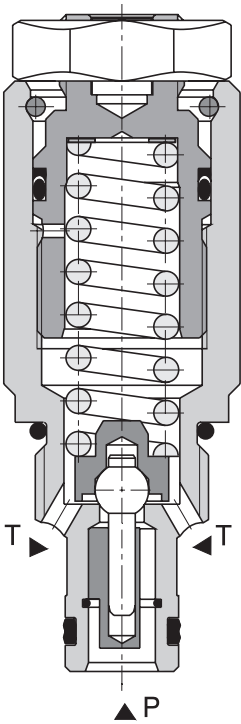

Technical Features

- › Excellent stability throughout flow range with rapid response to dynamic pressure changes
- › Low hysteresis, accurate pressure control and low pressure drop through CFD optimized flow paths
- › Wide pressure range up to 350 bar
- › Hardened precision parts
- › Sharp-edged steel seats for dirt-tolerant performance
- › Leak-free closing, suitable for fast cycling with long life
- › Adjustable by allen key or hand screw
- › In the standard version, the valve is zinc-coated for 240 h protection acc. to ISO 9227

Functional Description

A poppet type, direct acting hydraulic relief valve in the form of a screw-in cartridge intended for use as a pressure limiting device for common hydraulic circuit protection. The spring acts on the poppet and presses it onto the valve seat. If the hydraulic pressure is below the pre-set value, the valve is closed. If the hydraulic force exceeds the pre-set value the valve opens and flow passes to the tank port until the system pressure falls below the spring pre-set value and the valve closes again.

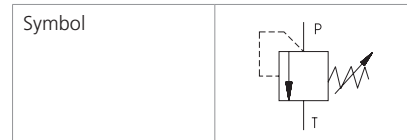

Technical Data

Valve size / Cartridge cavity		3/4-16 UNF-2A / A2 (C-8-2)	
Max. flow	l/min (GPM)	30 (7.9)	
Max. operating pressure	bar (PSI)	350 (5080)	
Max. pressure (port T)	bar (PSI)	160 (2320)	
Fluid temperature range (NBR)	°C (°F)	-30 ... +100 (-22 ... 212)	
Fluid temperature range (FPM)	°C (°F)	-20 ... +120 (-4 ... 248)	
Weight	kg (lbs)	0.13 (0.29)	
		Datasheet	Type
General information		GI_0060	Products and operating conditions
Valve bodies	In-line mounted	SB_0018	SB-A2*
	Sandwich mounted	SB-04(06)_0028	SB-*A2*
Cavity details / Form tools		SMT_0019	SMT-A2*
Spare parts		SP_8010	

Characteristics measured at $v = 32 \text{ mm}^2/\text{s}$ (156 SUS)

Relief pressure related to flow rate

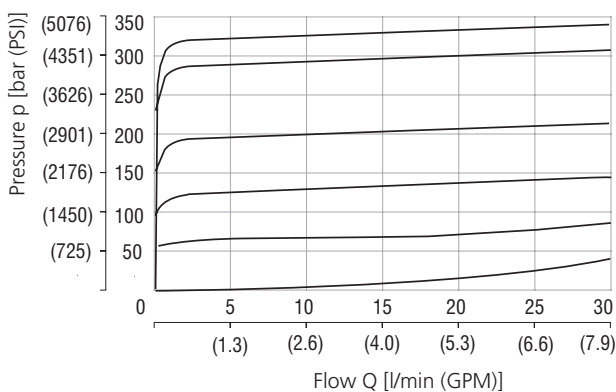

	Pressure range
6	35
5	25
4	16
3	10
2	6
1	Min. pressure setting

Dimensions in millimeters (inches)

Model S

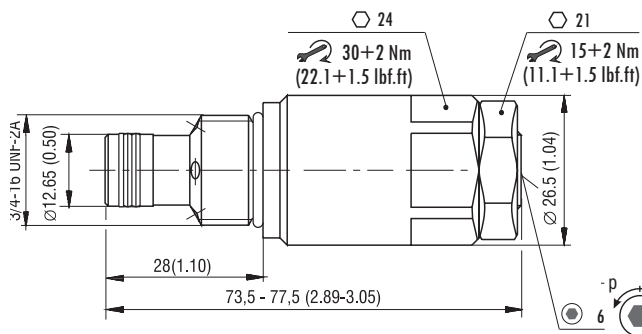

Model T

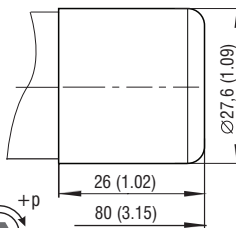

Model L

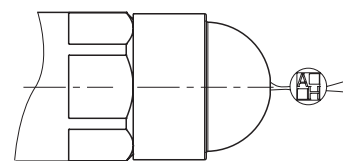

Typ RP

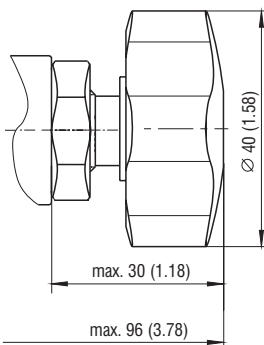

Ordering Code

SR1A-A2 / L [] [] [] - []

Pressure relief valve, poppet type, direct acting

Valve cavity
3/4-16 UNF (C-8-2)

Model
Lightline

Pressure range
up to 63 bar (914 PSI) 6
up to 100 bar (1450 PSI) 10
up to 160 bar (2320 PSI) 16
up to 250 bar (3630 PSI) 25
up to 350 bar (5080 PSI) 35

Surface treatment
A zinc-coated (ZnCr-3), ISO 9227 (240 h)
B zinc-coated (ZnNi), ISO 9227 (520 h)

Seals
No designation
V NBR
FPM (Viton)

Adjustment option
S allen key (hex. 6), without protective cap
T allen key (hex. 6), with protective cap
L allen key (hex. 6), with protective cap, sealable (lockwire holes)
RP hand screw, plastic